

# User Manual

## Off Grid Solar Inverter

01 HF Series

01 - HF - 3.6

01 - HF - 5.0

## CATALOGUE

About This Document .....	1
Purpose .....	1
Intended Audience .....	1
Safety Instructions .....	1
01 Introduction .....	2
1.1 Features .....	2
1.2 System Diagram .....	3
1.3 Product Overview .....	3
02 Installation .....	4
2.1 Unpacking and Inspection .....	4
2.2 Preparation .....	4
2.3 Mounting the Unit .....	4
2.4 Battery Connection .....	5
2.4.1 Lead-acid Battery Connection .....	5
2.4.2 Lithium Battery Connection .....	7
2.4.3 Lithium battery communication and setting .....	7
2.4.2 Communicating with battery BMS in parallel system .....	10
2.5 AC Input/Output Connection .....	11
2.6 PV Connection .....	12
2.7 Final Assembly .....	13
2.8 Communication Connection .....	14
2.9 Dry Contact Signal .....	14
03 Operation .....	15
3.1 Power ON/OFF .....	15
3.2 Operation and Display Panel .....	15
3.3 LED Indicator .....	16
3.4 Functional Keys .....	16
3.5 LCD Display Icons .....	17
3.6 LCD Setting .....	19
3.7 Display Information .....	30
3.8 Operating Mode Description .....	31
04 Parallel Installation Guide .....	33
4.1 Introduction .....	33
4.2 Package Contents .....	33
4.3 Mounting the Unit .....	33
4.4 Wiring Connection .....	34
4.5 Parallel Operation in Single Phase .....	36
4.7 PV Connection .....	39
4.8 LCD Setting and Display .....	39
4.8.1 Parallel in Single Phase .....	39
4.8.2 Parallel in Three Phase .....	40

05 Fault Reference Code .....	41
06 Warning Indicator .....	42
07 Battery Equalization .....	44
08 Specifications .....	46
09 Trouble Shooting .....	49

# About This Document

---

## Purpose

This manual contains important instructions for off grid solar inverter. It describes the assembly, installation, commissioning, maintenance and failure of the product. Please read it carefully before operating. Store this manual where it will be accessible at all times.

This manual is only for product of solar inverter including the model below:

<b>O1-HF-3.6</b>	<b>AC rated output power</b>	<b>3600w</b>
<b>O1-HF-5.0</b>	<b>AC rated output power</b>	<b>5000w</b>

## Intended Audience

This document is intended for qualified persons and end users. Tasks that do not require any particular qualification can also be performed by end users. Qualified persons must have the following skills:

- ① Qualified electrical technicians responsible for installing, wiring, commissioning, maintaining, and troubleshooting the O1 HF Series off-grid solar inverter.
- ② Training in how to deal with the dangers and risks associated with installing and using electrical devices and installations.
- ③ Knowledge of the applicable standards and directives.
- ④ Knowledge of and compliance with this document and all safety information.

## Safety Instructions

**WARNING: This chapter contains important safety and operating instructions. Read and keep this manual for future reference.**

1.Before using the unit, read all instructions and cautionary marking on the unit, the batteries and all appropriate sections of this manual. The company has the right not to quality assurance, if not according to the instructions of this manual for installation and cause equipment damage.

2.All the operation and connection must be performed by qualified electrical or mechanical engineer.

3.All the electrical installation must comply with the local electrical safety standards.

4.When install PV modules in the daytime, installer should cover the PV modules by opaque materials, otherwise it will be dangerous as high terminal voltage of modules in the sunshine.

5.CAUTION-To reduce risk of injury, charge only deep-cycle lead-acid type rechargeable batteries and lithium batteries. Other types of batteries may burst, causing personal injury and damage.

6. Do not disassemble the unit. Please contact to the qualified service center firstly when service or repair is required. Incorrect re-assembly may result in a risk of electric shock or fire.

7. To reduce risk of electric shock, please disconnect all wirings before attempting any maintenance or cleaning. Turning off the unit will not reduce this risk.

8. NEVER charge a frozen battery.

9. For optimum operation of this inverter, please follow required spec to select appropriate cable size. It's very important to correctly operate this inverter.

10. Be very cautious when working with metal tools on or around batteries. A potential risk exists to drop a tool to spark or short circuit batteries or other electrical parts and could cause an explosion.

11. Please strictly follow installation procedure when you want to disconnect AC or DC terminals. Please refer to INSTALLATION section of this manual for the details.

12. GROUNDING INSTRUCTIONS -This inverter should be connected to a permanent grounded wiring system. Be sure to comply with local requirements and regulation to install this inverter.

13. NEVER cause AC output and DC input short circuited. Do NOT connect to the mains when DC input short circuits.

14. Make sure the inverter is completely assembled, before the operation.

---

## 01 Introduction

This is a multi-functional off grid solar inverter built-in with a MPPT solar charger and a bi-directional pure sine wave inverter/charger. This unit has a UPS function module which is perfect for off grid backup power and self-consumption applications. This inverter can work with or without batteries.

This unit has several working modes for different purpose such as PV prior mode or battery prior mode. Its comprehensive LCD display offers an easy configuration of the unit such as battery charging current or charge priority by AC/PV charger.

The WIFI / GPRS module is a plug-and-play monitoring device to be installed on the inverter. With this device, users can monitor the status of the solar generation system on the APP of mobile phone or the internet browser anytime anywhere.

### 1.1 Features

- ❶ Rated pure sinewave output power of 3.6KW to 5KW.
- ❷ 450V Max PV input voltage and 120V~430V MPPT ranges.
- ❸ High frequency transformer isolated inverter with small size and light weight.
- ❹ UPS function available.
- ❺ Solar and utility grid can power up the loads simultaneously.
- ❻ Be able to work without battery.

- ⑦ WIFI/ GPRS remote monitoring (optional).
- ⑧ Parallel operation up to 6 unit (must be connected with battery).
- ⑨ CAN/RS485 for BMS communication.

## 1.2 System Diagram

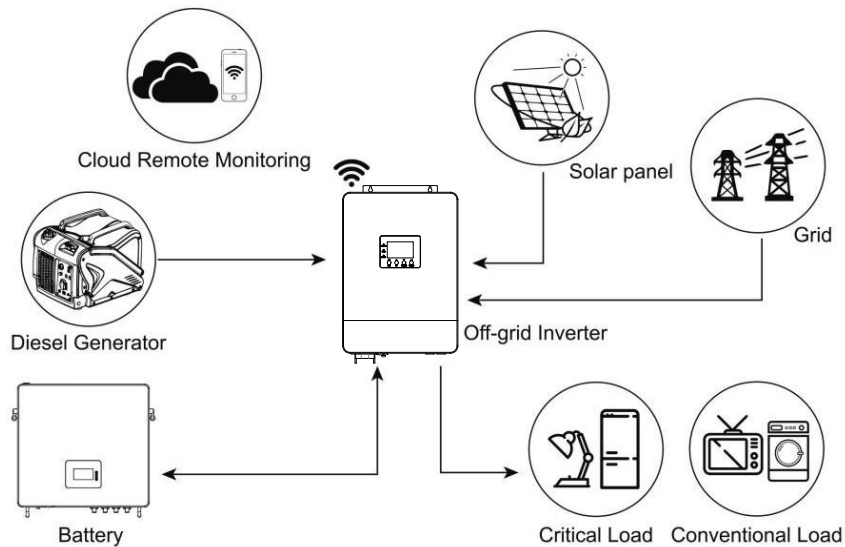

Fig.1 Basic system diagram

## 1.3 Product Overview

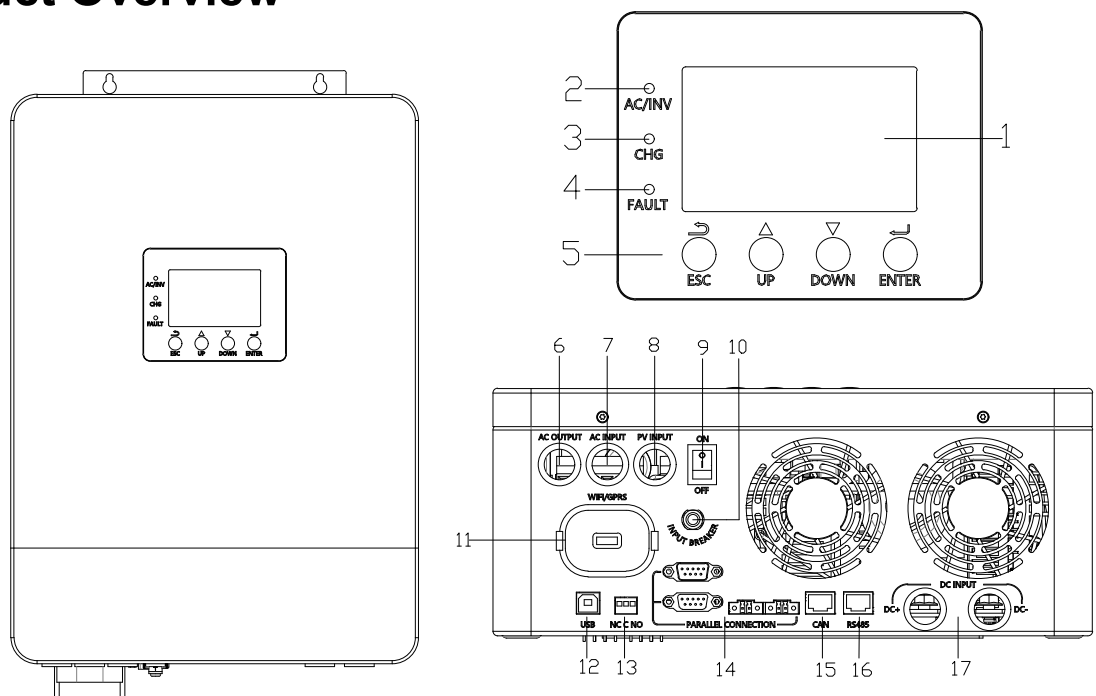

Fig.2 Interfaces of the unit

- |   |  |
|---|--|
| 1. LCD display  | 2. Inverter status indicator                 |
| 3. Charging state indicator                             | 4. Fault indicator                           |
| 5. Function keys  | 6. AC output                                 |
| 7. AC grid input  | 8. PV input                                  |
| 9. Power on/off switch                                  | 10. Input AC breaker                         |
| 11. WIFI/GPRS plug port                                 | 12. USB service port                         |
| 13. Dry contact   | 14. Parallel communication ports             |
| 15. BMS communication port (support CAN/RS485 protocol) | 16. RS485 communication port (for expansion) |
| 17. Battery DC input                                    |  |

## 02 Installation

### 2.1 Unpacking and Inspection

Before installation, please inspect the unit. Be sure that nothing inside the package is damaged. You should have received the following items in the package:

- |                            |      |                                |      |
|----------------------------|------|--------------------------------|------|
| ① The unit                 | 1pcs | ② Parallel communication cable | 1pcs |
| ③ User manual              | 1pcs | ④ Quick Installation Guide     | 1pcs |
| ⑤ Factory Report & QC Pass | 1pcs |                                |      |

### 2.2 Preparation

Before connecting all wiring, please take off bottom cover by removing two screws as shown below.

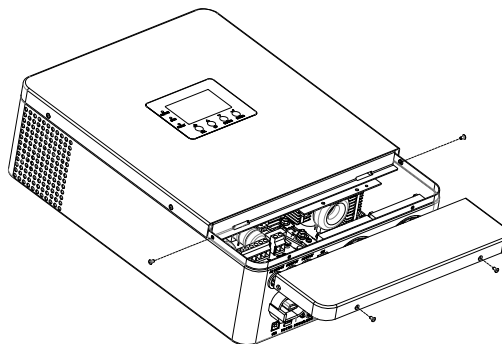

Fig.3 connection box of the unit

### 2.3 Mounting the Unit

Consider the following points before selecting where to install:

- ① Do not mount the inverter on flammable construction materials.
- ② Mount on a solid surface.
- ③ Install this inverter at eye level in order to allow the LCD display to be read at all times.

- ④ The ambient temperature should be between 0°C and 50°C to ensure optimal operation.
- ⑤ The recommended installation position is to be adhered to the wall vertically.
- ⑥ Be sure to keep other objects and surfaces as shown in the right diagram to guarantee sufficient heat dissipation and to have enough space for removing wires.

**⚠ SUITABLE FOR MOUNTING ON CONCRETE OR OTHER NON-COMBUSTIBLE SURFACE ONLY.**

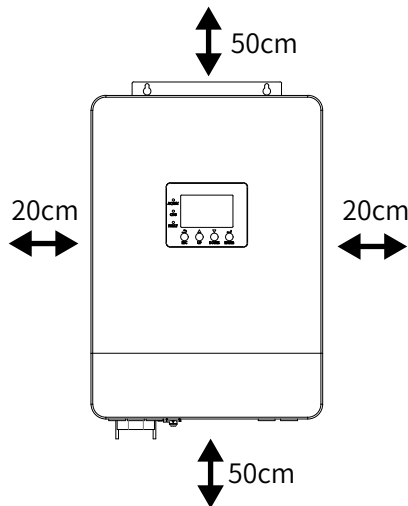

Fig.4 Installation space required

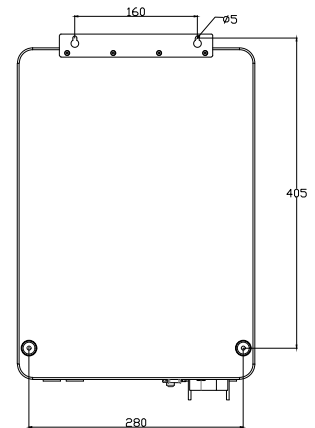
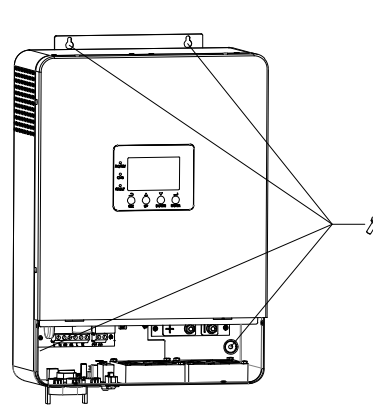

Fig.5 Mounting of the unit

Install the unit by screwing three screws. It's recommended to use M4 or M5 screws.

## 2.4 Battery Connection

### 2.4.1 Lead-acid Battery Connection

**WARNING:** All wiring must be performed by a qualified person.

Please use the battery with a nominal voltage at 48V. Also, you need to choose battery type as "AGM(default) or FLD".

**Note:** For lead acid battery, the recommended charge current is not larger than 0.2C(C→battery capacity).

**CAUTION:** For safety operation and regulation compliance, it's requested to install a separate DC over-current protector or disconnect device between battery and inverter. It may not be requested to have a disconnect device in some applications, however, it's still requested to have over-current protection installed. Please refer to typical amperage in below table as required fuse or breaker size.



**WARNING:** It's very important for system safety and efficient operation to use appropriate cable for battery connection. To reduce risk of injury, please use the proper recommended cable and terminal size as below.

Recommended battery cable and terminal size:

Model	Wire Size	Torque value
O1-HF-3.6	1 * 4 AWG	2-3 Nm
O1-HF-5.0	1 * 2 AWG	2-3 Nm

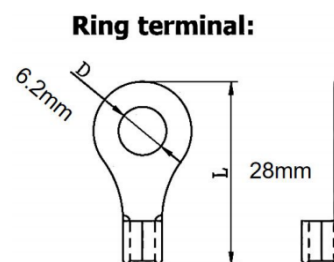

Fig.6 Ring terminal

Please follow below steps to implement battery connection:

- S1. Assemble battery ring terminal based on recommended battery cable and terminal size.
- S2. Connect all battery packs as units requires. It's suggested to connect at least 200Ah capacity battery for O1-HF-5.0 and at least 100Ah capacity battery for O1-HF-3.6.
- S3. Insert the ring terminal of battery cable flatly into battery connector of inverter and make sure the bolts are tightened with torque of 2-3Nm.

**WARNING:** Make sure polarity at both the battery and the inverter/charge is correctly connected and ring terminals are tightly screwed to the battery terminals.

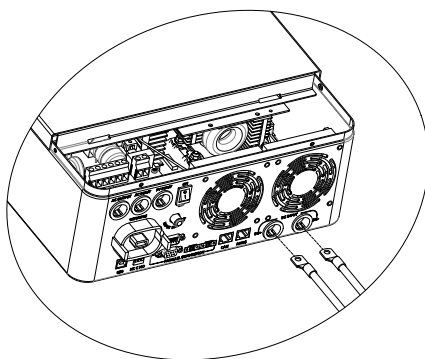

Fig.7 Mounting of the unit

	<p><b>WARNING: Shock Hazard</b> Installation must be performed with care due to high battery voltage in series.</p>
	<p><b>CAUTION!!</b> Do not place anything between the flat part of the inverter terminal and the ring terminal. Otherwise, overheating may occur. <b>CAUTION!!</b> Do not apply anti-oxidant substance on the terminals before terminals are connected tightly. <b>CAUTION!!</b> Before making the final DC connection or closing DC breaker/disconnector, be sure positive (+) must be connected to positive</p>

(+) and negative (-) must be connected to negative (-).
---

## 2.4.2 Lithium Battery Connection

If choosing lithium battery, you are allowed to use the lithium battery only which we have matched.

Please follow below steps to implement lithium battery connection:

S1. Assemble battery ring terminal based on recommended battery cable and terminal size (refer. To table1).

S2. Insert the ring terminal of battery cable flatly into battery connector of inverter and make sure the bolts are tightened with torque of 2-3Nm.

**WARNING:** Make sure polarity at both the battery and the inverter/charge is correctly connected and ring terminals are tightly screwed to the battery terminals.

S3. Connect the end of RJ45 of battery to BMS communication port(RS485 or CAN) of inverter.

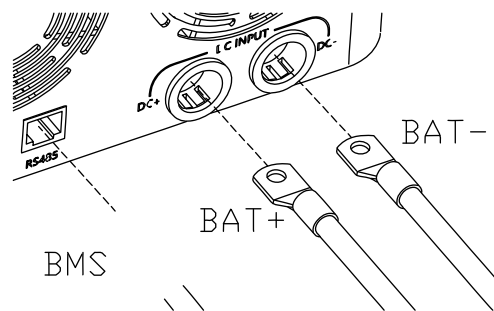

Fig.8 Schematic diagram of lithium battery connection

S4. The other end of RJ45 insert to battery communication port (RS485 or CAN).

**Note:** If choosing lithium battery, make sure to connect the BMS communication cable between the battery and the inverter. You need to choose battery type as 'lithium battery'.

## 2.4.3 Lithium battery communication and setting

1) **Connect the end of RJ45 of battery to BMS communication port of inverter**

Make sure the lithium battery BMS port connects to the inverter is Pin to Pin, the inverter BMS port pin and RS485 port pin assignment shown as below:

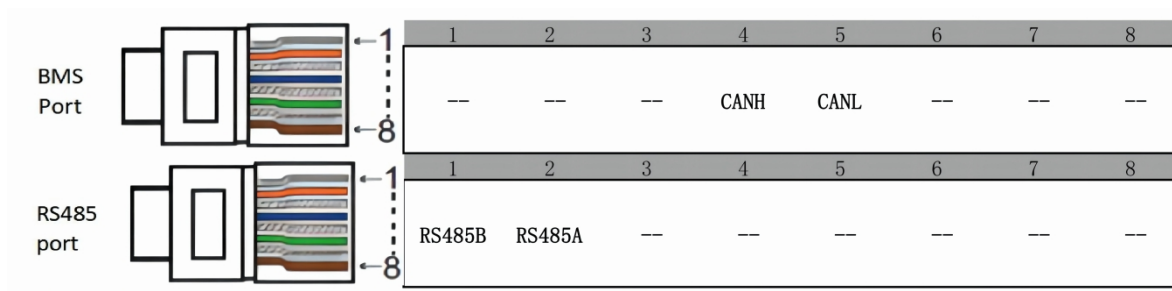

Fig.9 Interface allocation diagram

## 2) LCD setting

In order to communicate with battery BMS, you should set the battery type to “LI” in Program 7. Then the LCD will switch to Program 36, which is to set the protocol type. There are several protocols in the inverter. Please get instruction from service center to choose which protocol to match the BMS.

To connect battery BMS, need to set the battery type as “LI” in Program 7.

After set “LI” in Program 7, it will switch to Program 36 to choose communication protocol. You can choose RS485 communication protocol which is from L01 to L50, and you can also choose CAN communication protocol which is from L51 to L99.

7	Battery type		AGM (default)
			Flooded
			Lithium (only suitable when communicated with BMS)
			User-Defined If “User-Defined” is selected, battery charge voltage and low DC cut-off voltage can be set up in program 17, 18 and 19.

			<p>User-Defined 2 (suitable when lithium battery without BMS communication)</p> <p>If "User-Defined 2" is selected, battery charge voltage and low DC cut-off voltage can be set up in program 17, 18 and 19. It is recommended to set to the same voltage in program 17 and 18 (full charging voltage point of lithium battery). The inverter will stop charging when the battery voltage reaches this setting.</p>
36	RS485 Communi- cation protocol		Protocol 1
			Protocol 2
			Protocol 50
	CAN Communi- cation protocol		Protocol 51
			Protocol 52
			Protocol 99

**Note:** When the battery type set to Li, the setting option 12, 13, 19 will change to

display percent.

**Note:** When the battery type set as “LI”, the Maximum charge current can't be modified by the user. When the communication fails, the inverter will cut off output.

12	Setting SOC point back to utility source when selecting “SBU priority” or “Solar first” in program 01		Default 50%, 6%~95% Settable
13	Setting SOC point back to battery mode when selecting “SBU priority” or “Solar first” in program 01		Default 95%, 10%~100% Settable
19	Low DC cut-off SOC If “LI” is selected in program 7, this program can be set up		Default 20%, 5%~50% Settable

### 2.4.2 Communicating with battery BMS in parallel system

If need to use communicate with BMS in a parallel system, you should make sure to connect the BMS communication cable between the battery and one inverter of the parallel system. It’s recommended to connect to the master inverter of the parallel system.

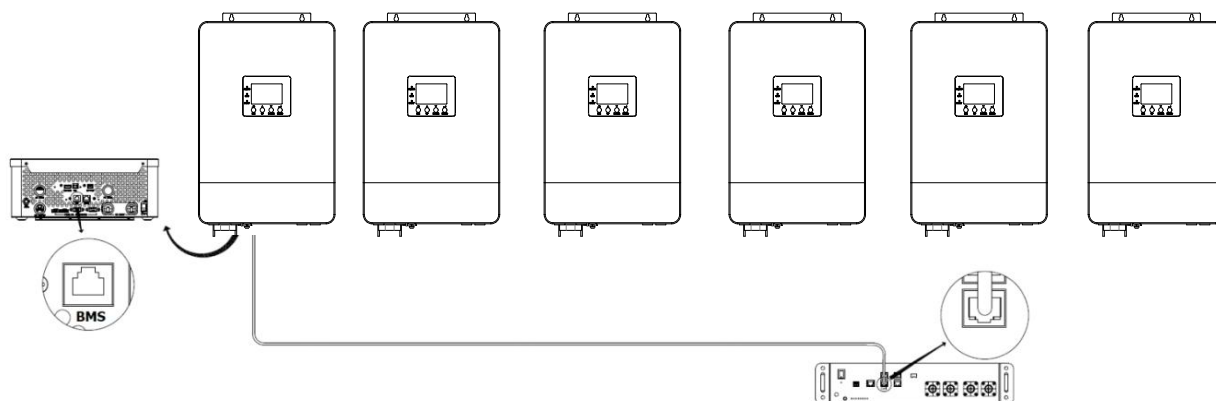

Fig.10 Parallel communication diagram

## 2.5 AC Input/Output Connection

**CAUTION!!** Before connecting to AC input power source, please install a separate AC breaker between inverter and AC power source. This will ensure the inverter can be securely disconnected during maintenance and fully protected from over current of AC input. The recommended spec of AC breaker is 40A for O1-HF-3.6 and 50A for O1-HF-5.0.

**CAUTION!!** There are two terminal blocks with "IN" and "OUT" markings. Please do NOT mis-connect input and output connectors.

**WARNING!** All wiring must be performed by a qualified person.

**WARNING!** It's very important for system safety and efficient operation to use appropriate cable for AC input connection. To reduce risk of injury, please use the proper recommended cable size as below.

Suggested cable requirement for AC wires:

Model	Wire Size	Torque value
O1-HF-3.6	1 * 10 AWG	1.2-1.6 Nm
O1-HF-5.0	1 * 8 AWG	1.2-1.6 Nm

Please follow below the steps to accomplish AC input/output connection:

S1. Be sure to disconnect both DC and AC breaker Before performing AC input/output connection.

S2. Remove insulation sleeve 10mm for six conductors. And shorten phase L and neutral conductor N 3mm.

S3. Insert AC input wires according to polarities indicated on terminal block and tighten the terminal screws. Be sure to connect PE protective conductor first.

**WARNING:**

Be sure that AC power source is disconnected before attempting to hardwire it to the unit.

S4. Insert AC output wires according to polarities indicated on terminal block and tighten terminal screws. For safety be sure to connect PE protective conductor first.

**PE→Potential Ground (yellow-green)**

**L→ LINE (brown or black)**

**N→ Neutral (blue)**

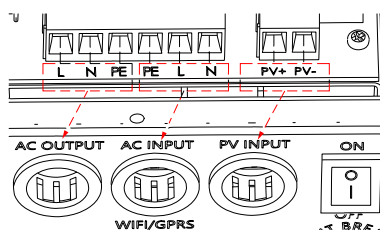

Fig.11 Schematic diagram of AC input/output connection

S5. Make sure the wires are securely connected.

**WARNING:**

Be sure to connect AC wires with correct polarity. If L and N wires are connected reversely, it may cause utility short-circuited when these inverters are worked in parallel operation.

**CAUTION:** Appliances such as air conditioner are required at least 2~3 minutes to restart because it's required to have enough time to balance refrigerant gas inside of circuits. If a power shortage occurs and recovers in a short time, it will cause damage to your connected appliances. To prevent this kind of damage, please check with manufacturer of air conditioner that if it's equipped with time-delay function before installation. Otherwise, this off grid solar inverter will trig overload fault and cut off output to protect your appliance but sometimes it still causes internal damage to the air conditioner.

## 2.6 PV Connection

**CAUTION:** Before connecting to PV modules, please install separately a DC circuit breaker between inverter and PV modules.

**WARNING!** All wiring must be performed by a qualified person.

**WARNING!** It's very important for system safety and efficient operation to use appropriate cable for PV module connection. To reduce risk of injury, please use the proper recommended cable size as below.

Model	Wire Size	Torque value
O1-HF-3.6	1 * 12 AWG	1.2-1.6 Nm
O1-HF-5.0	1 * 12 AWG	1.2-1.6 Nm

### PV Module Selection

When selecting proper PV modules, please be sure to consider below parameters:

1. Open circuit Voltage (Voc) of PV modules not exceeds max. PV array open circuit voltage of inverter.

2. Open circuit Voltage (Voc) of PV modules should be higher than min. battery voltage.

INVERTER MODEL	O1-HF-3.6	O1-HF-5.0
<b>Max. PV Array Open Circuit Voltage</b>	450Vdc	
<b>Start-up Voltage</b>	150Vdc	
<b>PV Array MPPT Voltage Range</b>	120Vdc~430Vdc	

Please follow below steps to implement PV module connection:

S1. Remove insulation sleeve 10 mm for positive and negative conductors.



Fig.12 Schematic diagram of AC input/output connection

S2. Check correct polarity of connection cable from PV modules and PV input connectors. Then, connect positive pole (+) of connection cable to positive pole (+) of PV input connector. Connect negative pole (-) of connection cable to negative pole (-) of PV input connector.

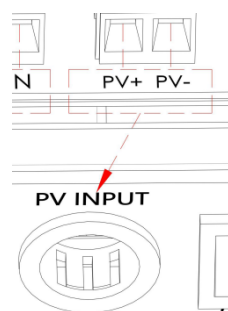

Fig.13 PV connection

S3. Make sure the wires are securely connected.

## 2.7 Final Assembly

After connecting all wiring, please put bottom cover back by screwing four screws as shown below.



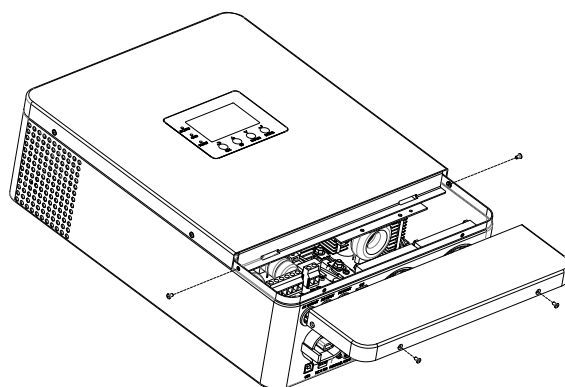

Fig.13 The assembly

## 2.8 Communication Connection

Please use supplied communication cable to connect to inverter and PC. Follow on-screen instruction to install the monitoring software. For the detailed software operation, please check user manual of software or contact your installer.

## 2.9 Dry Contact Signal

There is one dry contact(3A/250VAC) available on the rear panel. It could be used to deliver signal to external device when battery voltage reaches warning level.

Unit Status Condition		Dry contact port:	
		NC & C	NO & C
Power Off	Unit is off and no output is powered	Close	Open
	Output is powered from Utility	Close	Open
	Battery voltage (SOC) < Low DC warning voltage(SOC)	Open	Close
	Program 01 set as Utility first Battery voltage(SOC) > Setting value in Program 13 or battery charging reaches floating stage	Close	Open
Output is			

Power On	powered from Battery or Solar	Program 01 is set as SBU or Solar first	Battery voltage (SOC) < Setting value in Program 12	Open	Close
			Battery voltage (SOC) > Setting value in Program 13 or battery charging reaches floating stage	Close	Open

## 03 Operation

### 3.1 Power ON/OFF

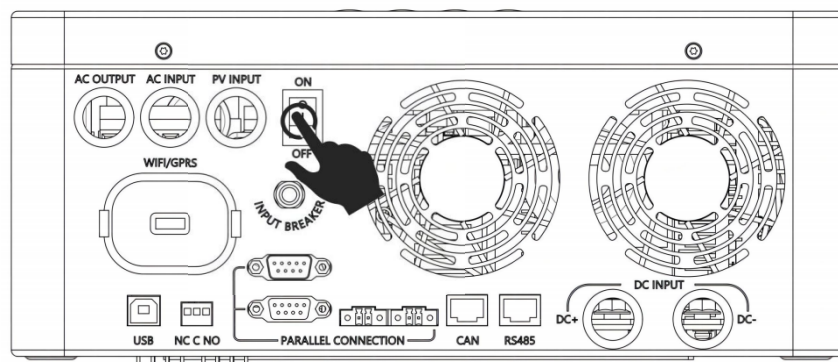

Fig.14 Start/Close

Once the unit has been properly installed and the batteries are connected well, press On/Off switch to turn on the unit.

### 3.2 Operation and Display Panel

The operation and display panel, shown in below chart, is on the front panel of the inverter. It includes three indicators, four function keys and an LCD display, indicating the operating status and input/output power information.

1. LCD display
2. Status indicator
3. Charging indicator
4. Fault indicator
5. Functional keys

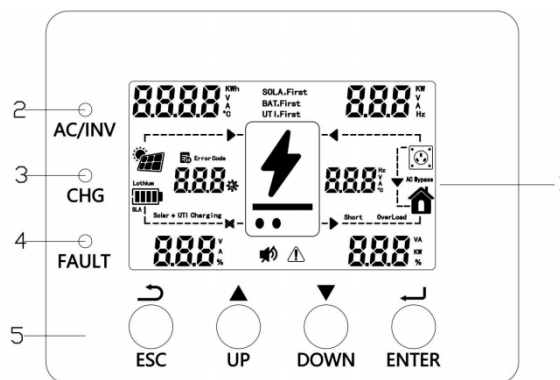

Fig.15 Display

### 3.3 LED Indicator

LED Indicator			Messages
○ AC/INV	Green	Solid On	Output is powered by utility in Line mode.
		Flashing	Output is powered by battery or PV in battery mode.
○ CHG	Green	Solid On	Battery is fully charged.
		Flashing	Battery is charging.
○ FAULT	Red	Solid On	Fault occurs in the inverter.
		Flashing	Warning condition occurs in the inverter.





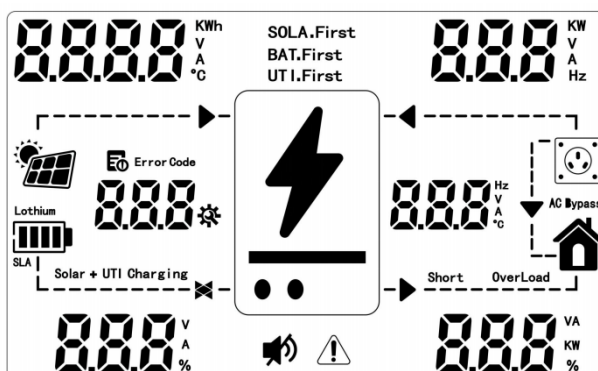

### 3.4 Functional Keys

Button	Description
ESC	To exit setting mode
UP	To go to previous selection
DOWN	To go to next selection
ENTER	To confirm the selection in setting mode or enter setting mode

### 3.5 LCD Display Icons





Icon	Description
<b>AC Input Information</b>	
	AC input icon
	Indicate AC input power, AC input voltage, AC input frequency, AC input current
<b>AC Bypass</b>	Indicate AC power loads in bypass
<b>PV Input Information</b>	
	PV input icon
	Indicate PV power, PV energy, PV voltage, PV current
<b>Output Information</b>	
	Inverter icon
	Indicate output voltage, output current, output frequency, inverter temperature
<b>Load Information</b>	
	Load icon
	Indicate power of load, power percentage of load
<b>OverLoad</b>	Indicate overload happened
<b>Short</b>	Indicate short circuit happened
<b>Battery Information</b>	
	Indicate battery level by 0-24%, 25-49%, 50-74% and 75-

	100% in battery mode and charging status in line mode.
	Indicate battery voltage, battery remain energy percentage, battery current
<b>Other Information</b>	
SOLA.First BAT.First UTI.First	Indicate output source priority: solar first, utility first, SBU mode or SUB mode
 Error Code	Indicate warning code or fault code
	Indicate it's during setting status
	Indicate error code or setting sequence NO.
	Indicate a warning or a fault is happening
	Indicate the alarm is disabled

In AC input mode, battery icon will present Battery Charging Status		
Status	Battery voltage	LCD Display
Constant Current mode/ Constant Voltage mode	<2V/cell	4 bars will flash in turns.
	2 ~ 2.083V/cell	Bottom bar will be on and the other three bars will flash in turns.
	2.083 ~ 2.167V/cell	Bottom two bars will be on and the other two bars will flash in turns.
	> 2.167 V/cell	Bottom three bars will be on and the top bar will flash.
Floating mode. Batteries are fully charged.		4 bars will be on.

In battery mode, battery icon will present Battery Capacity		
Load Percentage	Battery Voltage	LCD Display
	< 1.717V/cell	
	1.717V/cell ~ 1.8V/cell	



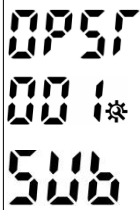

Load >50%	1.8 ~ 1.883V/cell	
	> 1.883 V/cell	
50%> Load > 20%	< 1.817V/cell	
	1.817V/cell ~ 1.9V/cell	
	1.9 ~ 1.983V/cell	
	> 1.983	
Load < 20%	< 1.867V/cell	
	1.867V/cell ~ 1.95V/cell	
	1.95 ~ 2.033V/cell	
	> 2.033	

### 3.6 LCD Setting

After pressing and holding ENTER button for 3 seconds, the unit will enter setting mode. Press “UP” or “DOWN” button to select setting programs. Then press “ENTER” button to confirm the selection or ESC button to exit.

Program	Description	Setting Option
		<p>Solar first</p>  <p>Solar energy provides power to the loads as first priority.                      If solar energy is not sufficient to power all connected loads, battery energy will supply power the loads at the same time.                      Utility provides power to the loads only when any one condition happens:                      - Solar energy is not available                      - Battery voltage drops to either low-level warning voltage or the setting point in program 12.</p>
		<p>Utility first</p> <p>Utility will provide power to the loads as first priority.                      Solar and battery energy will provide</p>

01	<p>Output source priority: To configure load power source priority</p>	<p>Utility first (default)</p> <p>0P5T 00 1* 0U1</p>	<p>power to the loads only when utility power is not available.</p>
		<p>SBU priority</p> <p>0P5T 00 1* 0U1</p>	<p>Solar energy provides power to the loads as first priority. If solar energy is not sufficient to power all connected loads, battery will supply power to the loads at the same time. Utility provides power to the loads only when battery voltage drops to either low-level warning voltage or the setting point in program 12.</p>
		<p>SUB priority</p> <p>0P5T 00 1* 5U6</p>	<p>Solar energy provides power to the loads as first priority. If solar energy is not sufficient to power all connected loads, solar and utility will power loads at the same time. Battery provides power to the loads only when solar energy is not sufficient and there is no utility.</p>
02	<p>Charger source priority: To configure charger source priority</p>	<p>Solar first</p> <p>CH0T 002* 050</p>	<p>when solar inverter is working in Line, Standby or Fault mode, charger source can be programmed as below:</p> <p>Solar energy will charge battery as first priority. Utility will charge battery only when solar energy is not available.</p>

		<p>Solar and Utility</p> 	<p>Solar energy and utility will both charge battery.</p>
		<p>Only Solar</p> 	<p>Solar energy will be the only charger source no matter utility is available or not.</p>
<p>If this off grid solar inverter is working in Battery mode or Power saving mode, only solar energy can charge battery. Solar energy will charge battery if it's available and sufficient.</p>			
<p>03</p>	<p>Maximum charging current: set total charging current for solar and utility chargers. (Max. charging current = utility charging current + solar charging current)</p>		<p>O1-HF-3.6 Default 60A, 10A~80A Settable O1-HF-5.0 Default 60A, 10A~100A Settable (If LI is selected in Program 7, this program can't be set up)</p>
<p>04</p>	<p>Maximum utility charging current Note: If setting value in Program 3 is smaller than that in Program 4, the inverter will apply charging current from Program 3 for utility charger</p>		<p>O1-HF-3.6 Default 20A, 0A~60A Settable O1-HF-5.0 Default 20A, 0A~80A Settable</p>









05	AC input voltage range		Appliance (default) If selected, acceptable AC input voltage range will be within 90~280VAC
			UPS If selected, acceptable AC input voltage range will be within 170~280VAC
			Generator (Only diesel generators allowed) If selected, acceptable AC input voltage range will be within 90~280VAC. Note: When connecting generator, the generator should be no less than 10KVA (no less than 20KVA for three phase parallel system), and the inverters should be no more than 2 units in one phase.
06	Power saving mode enable/disable		Saving mode disable (default) If disabled, no matter connected load is low or high, the on/off status of inverter output will not be effected.
			Saving mode enable If enabled, the output of inverter will be off when connected load is pretty low or not detected.
07	Battery type		AGM (default)
			Flooded

		<p>bAtn 007* L</p>	<p>Lithium (only suitable when communicated with BMS)</p>
		<p>bAtn 007* USE</p>	<p>User-Defined If “User-Defined” is selected, battery charge voltage and low DC cut-off voltage can be set up in program 17, 18 and 19.</p>
		<p>bAtn 007* US2</p>	<p>User-Defined 2 (suitable when lithium battery without BMS communication) If “User-Defined 2” is selected, battery charge voltage and low DC cut-off voltage can be set up in program 17, 18 and 19. It is recommended to set to the same voltage in program 17 and 18(full charging voltage point of lithium battery). The inverter will stop charging when the battery voltage reaches this setting.</p>
08	Auto restart when overload occurs	<p>Restart disable (default) 0d75 008* d15</p>	<p>Restart enable 0d75 008* ENR</p>
09	Auto restart when over temperature occurs	<p>Restart disable (default) 0e75 009* d15</p>	<p>Restart enable 0e75 009* ENR</p>

10	Output voltage *This setting is only available when the inverter is in standby mode (Switch off).	230V (default) 0PV 01 0 <sup>※</sup> 230	220V 0PV 01 0 <sup>※</sup> 220
		240V 0PV 01 0 <sup>※</sup> 240	208V 0PV 01 0 <sup>※</sup> 208
11	Output frequency *This setting is only available when the inverter is in standby mode (Switch off).	50Hz (default) 0PF 01 1 <sup>※</sup> 50	60Hz 0PF 01 1 <sup>※</sup> 60
12	Setting SOC point back to utility source when selecting "SBU priority" or "Solar first" in program 01	62.8% 01 2 <sup>※</sup> 46.0%	Default 46%, 6%~95% Settable
13	Low DC cut-off SOC If "LI" is selected in program 5, this program can be set up	62.6% 01 3 <sup>※</sup> 46.0%	Default 20%, 5%~50% Settable
14	Alarm control	Alarm on (default) ALTA 01 4 <sup>※</sup> ON	Alarm off ALTA 01 4 <sup>※</sup> OFF

15	Backlight control	Backlight on (default)  L1 HL 01 5* ON	Backlight off  L1 HL 01 5* OFF
16	Overload bypass: When enabled, the unit will transfer to line mode if overload occurs in battery mode.	Bypass disable (default)  byp 01 6* 01 5	Bypass enable  byp 01 6* ENR
17	C.V. charging voltage. If self-defined is selected in program 7, this program can be set up	CV 01 7* 56.4V	Default 56.4V, 48.0V~58.4V Settable
18	Floating charging voltage. If self-defined is selected in program 7, this program can be set up	FLTV 01 8* 54.0V	Default 54.0V, 48.0V~58.4V Settable
19	Low DC cut-off voltage. If self-defined is selected in program 7, this program can be set up. Low DC cut-off voltage will be fixed to setting value no matter what percentage of load is connected.	LOWV 01 9* 42.0V	Default 42.0V, 40.0V~48.0V Settable When reach Low DC cut-off voltage: 1) If battery power is only power source available, inverter will shut down. 2) If PV energy and battery power are available, inverter will charge battery without AC output. 3) If PV energy, battery power and utility are all available, inverter will transfer to line mode and provide output power to loads, and charge the battery at the same time.

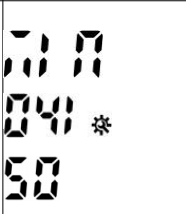
<p>20</p>	<p>AC output mode *This setting is only available when the inverter is in standby mode (Switch off). Note: Parallel operation can only work when battery connected</p>	<p>Single: PAR5 020* 310</p>	<p>Parallel: PAR5 020* PAL</p>
		<p>L1 Phase: PAR5 020* 3P1</p>	<p>L2 Phase: PAR5 020* 3P2</p>
		<p>L3 Phase PAR5 020* 3P3</p>	
		<p>When the units are used in parallel with single phase, please select “PAL” in program 20. It requires 3 inverters to support three-phase equipment, 1 inverter in each phase. Please select “3P1” in program 20 for the inverters connected to L1 phase, “3P2” in program 20 for the inverters connected to L2 phase and “3P3” in program 20 for the inverters connected to L3 phase. Be sure to connect parallel cable to units which are on the same phase. Do NOT connect parallel cable between units on different phases. Besides, power saving function will be automatically disabled.</p>	
<p>28</p>	<p>Address setting (for expansion)</p>	<p>Default 1, 1~255 Settable Addr 028* 50</p>	

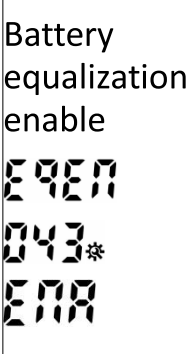
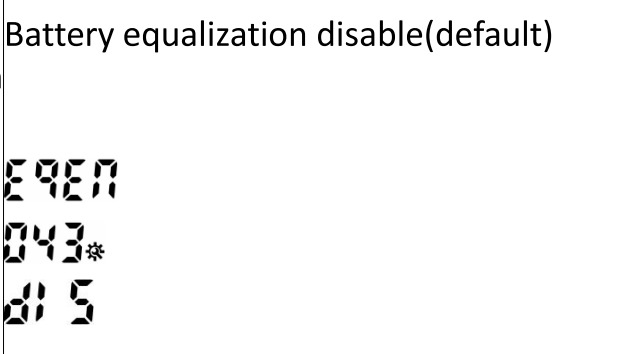
37	Real time setting---Year		Default 2000, range 2018~2099
38	Real time setting---Month		Default 01, range 01~12
39	Real time setting---Date		Default 01, range 01~31
40	Real time setting---Hour		Default 00, range 00~23
41	Real time setting---Minute		Default 00, range 00~59
42	Real time setting---Second		Default 00, range 00~59
43	Battery equalization	Battery equalization enable 	Battery equalization disable(default) 
		If “Flooded” or “User-Defined” is selected in program 07, this program can be set up.	

45	Battery equalized time	<p>E925      70 0</p> <p>045*</p> <p>60</p>	Default 60min, 5min~900min Settable
46	Battery equalized timeout	<p>E920      70 0</p> <p>046*</p> <p>120</p>	Default 120min, 5min~900min Settable
47	Equalization interval	<p>E912      d89</p> <p>047*</p> <p>31</p>	Default 31days,1 days~90 days Settable
48	Equalization activated immediately	<p>Equalization activated immediately on</p> <p>E9A2</p> <p>048*</p> <p>00</p>	<p>Equalization activated immediately off(default)</p> <p>E9A2</p> <p>048*</p> <p>OFF</p> <p>If equalization function is enabled in program 43, this program can be setup. If “On” is selected in this program, it’s to activate battery equalization immediately and LCD main page will show “E9”. If “Off” is selected, it will cancel equalization function until next activated equalization time arrives based on program 47setting. At this time, “E9” will not be shown in LCD main page.</p>

<p>49</p> <p>Utility charging time</p>	<p>0000(default) Allow utility to charge the battery all day run.</p> <p>08:4      CHG 049*      21:5</p>	<p>The time allows utility to charge the battery. Use 4 digits to represent the time period, the upper two digits represent the time when utility start to charge the battery, setting range from 00 to 23, and the lower two digits represent the time when utility end to charge the battery, setting range from 00 to 23. (Eg: 2320 represents the time allows utility to charge the battery is from 23:00 to the next day 20:59, and the utility charging is prohibited outside of this period)</p>
<p>50</p> <p>AC output time</p>	<p>0000(default) Allow inverter to power the load all day run.</p> <p>0000      OVP 050*      21:5</p>	<p>The time allows inverter to power the load. Use 4 digits to represent the time period, the upper two digits represent the time when inverter start to power the load, setting range from 00 to 23, and the lower two digits represent the time when inverter end to power the load, setting range from 00 to 23. (Eg: 2320 represents the time allows inverter to power the load is from 23:00 to the next day 20:59, and the inverter AC output power is prohibited outside of this period)</p>



### 3.7 Display Information

The LCD display information will be switched in turns by pressing “UP” or “DOWN” key. The selectable information is switched as below order: voltage, frequency, current, power, firmware version.

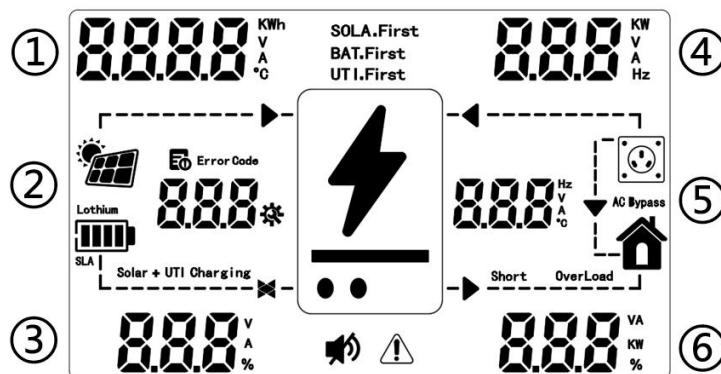





Display Information	LCD display
<ul style="list-style-type: none"> <li>① PV input voltage</li> <li>③ Battery voltage</li> <li>④ AC Input voltage</li> <li>⑤ Output voltage</li> <li>⑥ Load percentage (Default Display Screen)</li> </ul>	<p>The LCD display shows: 3200 v (top left), 220 v (top right), 502 v (bottom left), and 104 % (bottom right). The central lightning bolt icon is present.</p>
<ul style="list-style-type: none"> <li>① PV energy sum in KWH</li> <li>③ Battery remaining capacity</li> <li>④ AC Input frequency</li> <li>⑤ Inverter output frequency</li> <li>⑥ Load power in VA</li> </ul>	<p>The LCD display shows: 16 KWh (top left), 50 Hz (top right), 71 % (bottom left), and 688 VA (bottom right). The central lightning bolt icon is present.</p>

<ul style="list-style-type: none"> <li>① PV input current</li> <li>③ Battery charging current</li> <li>④ AC Input current</li> <li>⑤ Output current</li> <li>⑥ Load percentage</li> </ul>	
<ul style="list-style-type: none"> <li>① PV energy sum in KWH</li> <li>③ Battery percentage</li> <li>④ AC input power in Watts</li> <li>⑤ Inverter temperature</li> <li>⑥ Load power in Watts</li> </ul>	
<p>Firmware version</p>	
<p>Time</p>	

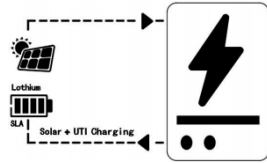
### 3.8 Operating Mode Description

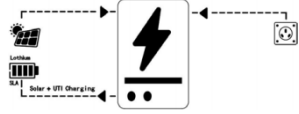
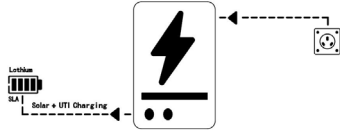
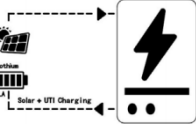
Operation mode	Description	LCD display	
<p>Standby mode / Power saving mode</p> <p>Note: *Standby mode: The inverter is not turned on yet but at this time, the inverter can charge</p>	<p>No output is supplied by the unit but</p>	<p>Charging by utility and PV energy.</p>	<p>Charging by utility</p>

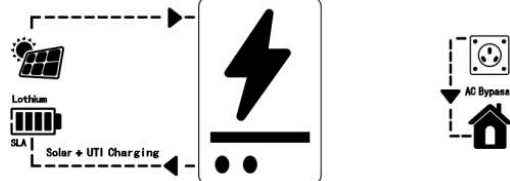
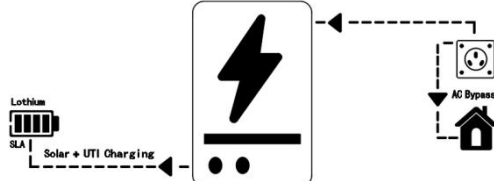
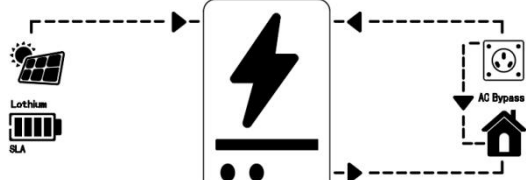
<p>battery without AC output. *Power saving mode: If enabled, the output of inverter will be off when connected load is pretty low or not detected.</p>	<p>it still can charge batteries.</p>	<p>Charging by PV energy</p> 	<p>No charging</p> 
<p>Fault mode Note:*Fault mode: Errors are caused by inside circuit error or external reasons such as over temperature, output short circuited and so on.</p>	<p>PV energy and utility can charge batteries.</p>	<p>Charging by utility and PV Energy</p> 	<p>Charging by utility</p> 
		<p>Charging by PV energy</p> 	<p>No charging</p> 
<p>Line Mode</p>	<p>The unit will provide output power from the mains. It can also charge the battery at line mode.</p>	<p>Charging by PV energy</p> 	<p>Charging by utility</p> 
		<p>No battery connected</p> 	
		<p>Power from battery and PV energy</p>	

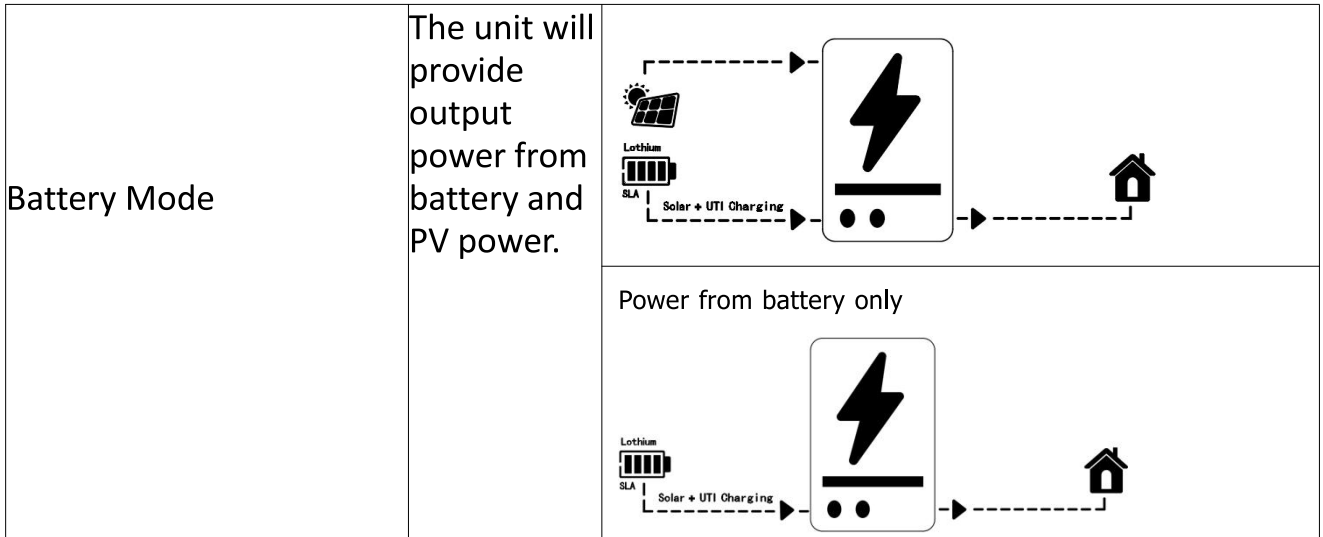

## 04 Parallel Installation Guide

### 4.1 Introduction

This inverter can be used in parallel with two different configurations.

- 1.Parallel operation in single phase with up to 6 units.
- 2.Maximum 6 units work together to support 3-phase equipment. 4 units support one phase maximum.

### 4.2 Package Contents

In parallel kit, you will find the following items in the package:



Fig.16 Parallel cable

### 4.3 Mounting the Unit

When installing multiple units, please follow below chart.

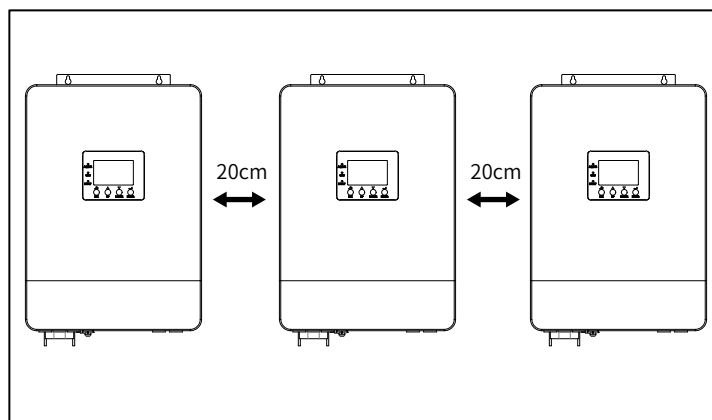

Fig.17 Installation space required

**Note:** For proper air circulation to dissipate heat, allow a clearance of approx. 20cm to the side and approx. 50 cm above and below the unit. Be sure to install each unit in the same level.

## 4.4 Wiring Connection

The cable size of each inverter is shown as below.

Recommended battery cable and terminal size for each inverter:

Model	Wire Size	Torque value
O1-HF-3.6	1 * 4 AWG	2-3 Nm
O1-HF-5.0	1 * 2 AWG	2-3 Nm

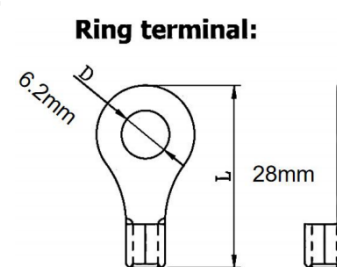

Fig.18 Ring terminal

**WARNING:** Be sure the length of all battery cables is the same. Otherwise, there will be voltage difference between inverter and battery to cause parallel inverters not working.

You need to connect the cables of each inverter together. Take the battery cables for example: You need to use a connector or bus-bar as a joint to connect the battery cables together, and then connect to the battery terminal. The cable size used from

joint to battery should be X times cable size in the tables above. "X" indicates the number of inverters connected in parallel.

Regarding AC input and output, please also follow the same principle.

Recommended AC input and output cable size for each inverter:

Model	Gauge	Torque Value
O1-HF-3.6	1 * 10 AWG	1.2- 1.6 Nm
O1-HF-5.0	1 * 8 AWG	1.2- 1.6 Nm

**CAUTION!!** Please install the breaker at the battery and AC input side. This will ensure the inverter can be securely disconnected during maintenance and fully protected from over current of battery or AC input.

Recommended breaker specification of battery for each inverter:

Model	1 unit*
O1-HF-3.6	100A / 60VDC
O1-HF-5.0	150A / 60VDC

\*If you want to use only one breaker at the battery side for the whole system, the rating of the breaker should be X times current of 1 unit. "X" indicates the number of inverters connected in parallel.

Recommended breaker specification of AC input with single phase:

Model	2 units	3 units	4 units	5 units	6 units
O1-HF-3.6	80A/230VAC	120A/230VAC	160A/230VAC	200A/230VAC	240A/230VAC
O1-HF-5.0	100A/230VAC	150A/230VAC	200A/230VAC	250A/230VAC	300A/230VAC

**Note1:** You can use 40A breaker for O1-HF-3.6 and 50A for O1-HF-5.0 for only 1 unit, and each inverter has a breaker at its AC input.

**Note2:** Regarding three phase system, you can use 4 poles breaker, the rating is up to the current of the phase which has the maximum units. Or you can follow the suggestion of note 1.

Recommended battery capacity:

Inverter parallel numbers	2	3	4	5	6
Battery Capacity	400AH	600AH	800AH	1000AH	1200AH

**WARNING!** Be sure that all inverters will share the same battery bank. Otherwise, the inverters will transfer to fault mode.

## 4.5 Parallel Operation in Single Phase

**WARNING!** All inverters must be connected to the same batteries and ensure each group of cables from the inverters to the batteries in the same length.

- **Two inverters in parallel:  
Power Connection**

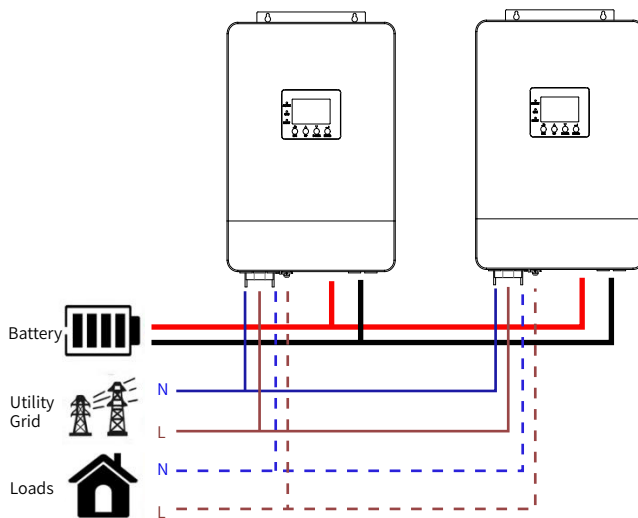

### Communication Connection

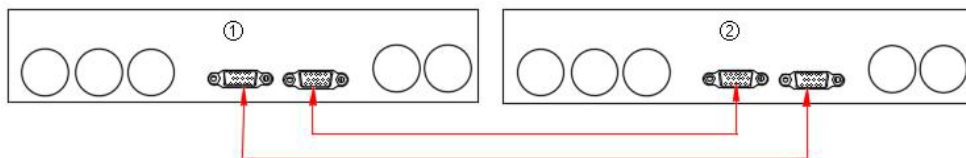

### Three inverters in parallel: Power Connection

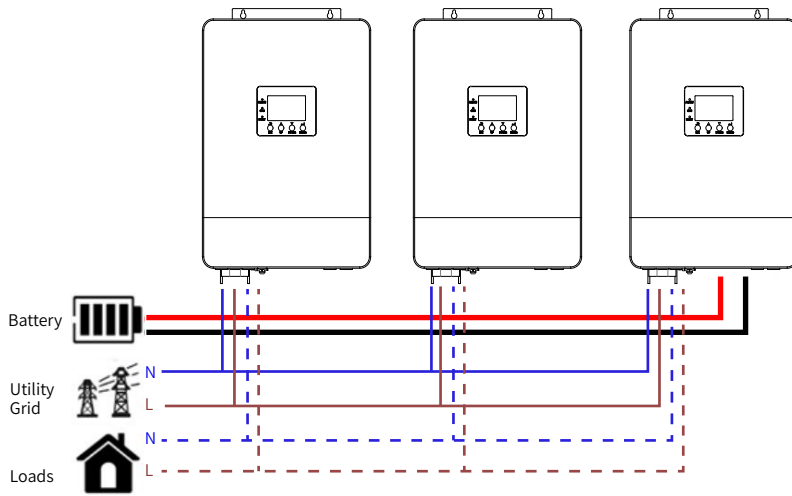

### Communication Connection

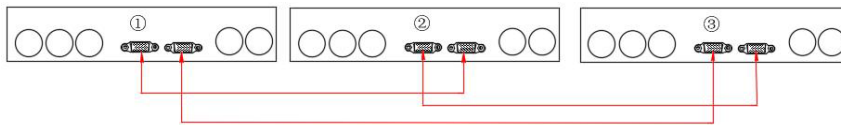

### Four inverters in parallel: Power Connection

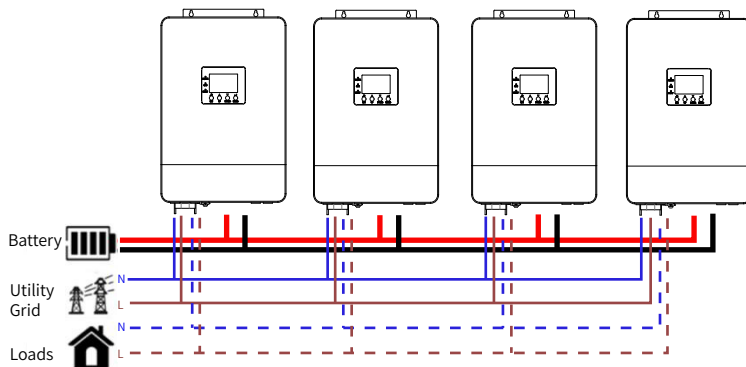

### Communication Connection

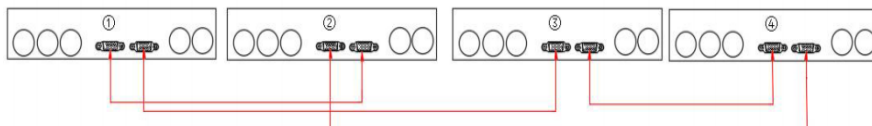



### Five inverters in parallel: Power Connection

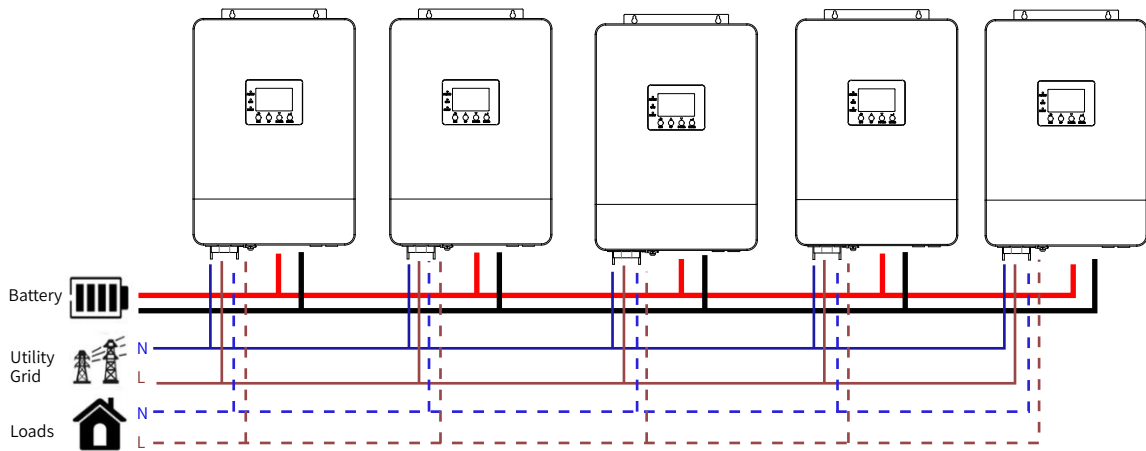

### Communication Connection

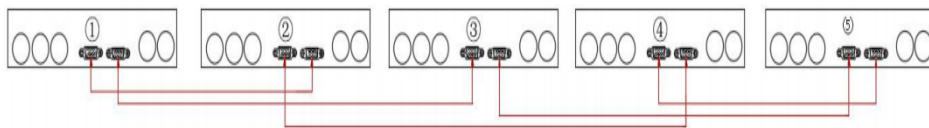

### Six inverters in parallel: Power Connection

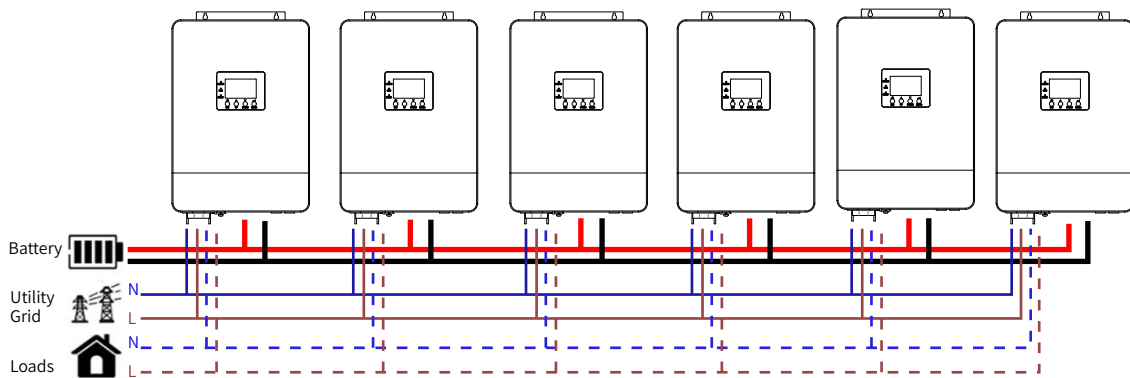

### Communication Connection

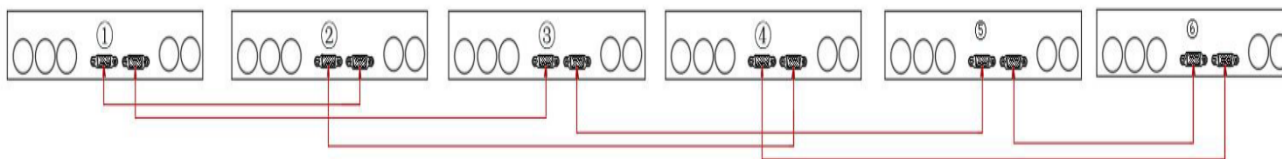

## 4.7 PV Connection

Please refer to user manual of single unit for PV Connection on section 2.6.

**CAUTION:** Each inverter should connect to PV modules separately .

## 4.8 LCD Setting and Display

Refer to Program 23 on section 3.6

### 4.8.1 Parallel in Single Phase

S1: Check the following requirements before commissioning:

- Correct wire connection
- Ensure all breakers in Line wires of load side are open and each Neutral wires of each unit are connected together.

S2: Turn on each unit and set “PAL” in LCD setting program 23 of each unit. And then shut down all units. Note: It’s necessary to turn off switch when setting LCD program. Otherwise, the setting can not be programmed.

S3: Turn on each unit.

LCD display in Master unit	LCD display in Slave unit

**Note:** Master and slave units are randomly defined.

S4: Switch on all AC breakers of Line wires in AC input. It’s better to have all inverters connect to utility at the same time. If not, it will display warning 15.

LCD display in Master unit	LCD display in Slave unit

S5: If there is no more fault alarm, the parallel system is completely installed.

S6: Please switch on all breakers of Line wires in load side. This system will start to provide power to the load.

### 4.8.2 Parallel in Three Phase

Step 1: Check the following requirements before commissioning:

- Correct wire connection
- Ensure all breakers in Line wires of load side are open and each Neutral wires of each unit are connected together.

Step 2: Turn on all units and configure LCD program 23 as P1, P2 and P3 sequentially. Then shut down all units.

**Note:** It's necessary to turn off switch when setting LCD program. Otherwise, the setting can not be programmed.

Step 3: Turn on all units sequentially. Please turn on HOST inverter first, then turn on the rest one by one.

LCD display in L1-phase unit	LCD display in L2-phase unit	LCD display in L3-phase unit

Step 4: Switch on all AC breakers of Line wires in AC input. If AC connection is detected and three phases are matched with unit setting, they will work normally. Otherwise, they will display warning 15/16 and will not work in the line mode.

LCD display in L1-phase unit	LCD display in L2-phase unit	LCD display in L3-phase unit

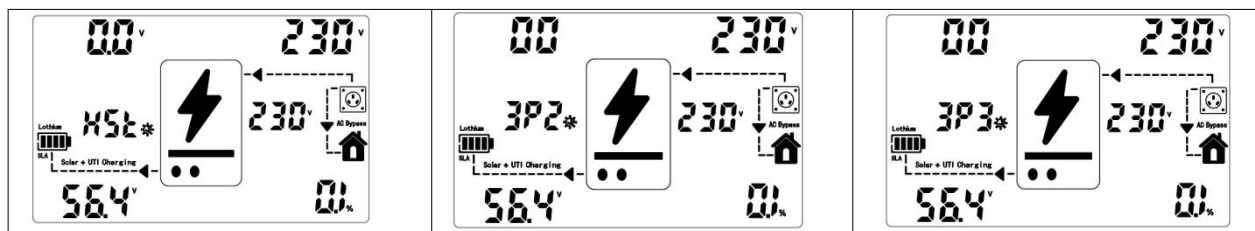

Step 5: If there is no more fault alarm, the system to support 3-phase equipment is completely installed.









Step 6: Please switch on all breakers of Line wires in load side. This system will start to provide power to the load.













**Note 1:** If there's only one inverter in L1-phase, the LCD will show as "HST". If there is more than one inverter in L1-phase, the LCD of the HOST inverter will show as "HST", the rest of L1-phase inverters will show as "3P1".

**Note 2:** To avoid overload occurring, before turning on breakers in load side, it's better to have whole system in operation first.





**Note 3:** Transfer time for this operation exists. Power interruption may happen to critical devices, which cannot bear transfer time.

## 05 Fault Reference Code

Fault Code	Fault Event	Icon on
01	Fan is locked	
02	Over temperature	
04	Battery voltage is too high	
05	Battery voltage is too low	
06	Output short circuited	
07	Output voltage is too high.	
08	Overload time out	
09	Bus voltage is too high	
10	Bus soft start failed	

52	Over current or surge	 Error Code 52
53	Bus voltage is too low	 Error Code 53
54	Inverter soft start failed	 Error Code 54
56	Over DC voltage in AC output	 Error Code 56
57	Battery connection is open	 Error Code 57
58	Current sensor failed	 Error Code 58
59	Output voltage is too low	 Error Code 59
61	Negative power fault	 Error Code 61
62	PV voltage is too high	 Error Code 62
63	Internal communication error	 Error Code 63
81	CAN fault	 Error Code 81
82	Host loss	 Error Code 82

## 06 Warning Indicator

Warning Code	Warning Event	Audible Alarm	Icon flashing
02	Fan is locked when inverter is on.	Beep 3 times every second	02 
03	Over temperature	Beep once every second	03 
04	Battery is over-charged	Beep once every second	04 
05	Low battery	Beep once every second	05 
08	Overload	Beep once every 0.5 second	08 

11	Output power derating	Beep twice every 3 seconds	11 !
13	Solar charger stops due to low battery	Beep once every second	13 !
14	Solar charger stops due to high PV voltage	Beep once every second	14 !
15	Solar charger stops due to overload	Beep once every second	15 !
16	Parallel input utility grid different	Beep once every second	16 !
17	Parallel input phase error	Beep once every second	17 !
18	Parallel output phase loss	Beep once every second	18 !
19	Buck over current	Beep once every second	19 !
20	Battery disconnect	No beep	20 !
21	BMS communication error	Beep once every second	21 !
22	PV power insufficient	Beep once every second	22 !
23	Parallel forbidden without battery	Beep once every second	23 !
26	Parallel inverters' capacity different	Beep once every second	26 !
34	BMS communication loss	Beep once every second	34 !
35	Cell over voltage	Beep once every second	35 !
36	Cell under voltage	Beep once every second	36 !
37	Total over voltage	Beep once every second	37 !
38	Total under voltage	Beep once every second	38 !
39	Discharge over voltage	Beep once every second	39 !
40	Charge over voltage	Beep once every second	40 !
41	Discharge over temperature	Beep once every second	41 !

42	Charge over temperature	Beep once every second	42 !
43	Mosfet over temperature	Beep once every second	43 !
44	Battery over temperature	Beep once every second	44 !
45	Battery under temperature	Beep once every second	45 !
46	System shut down	Beep once every second	46 !

## 07 Battery Equalization

Equalization function is added into charge controller. It reverses the buildup of negative chemical effects like stratification, a condition where acid concentration is greater at the bottom of the battery than at the top. Equalization also helps to remove sulfate crystals that might have built up on the plates. If left unchecked, this condition, called sulfation, will reduce the overall capacity of the battery. Therefore, it's recommended to equalize battery periodically.

- **How to Apply Equalization Function**

You must enable battery equalization function in monitoring LCD setting program 43 first. Then, you may apply this function in device by either one of following methods:

1. Setting equalization interval in program 47.
2. Active equalization immediately in program 48.

- **When to Equalize**

In float stage, when the setting equalization interval (battery equalization cycle) is arrived, or equalization is active immediately, the controller will start to enter Equalize stage.

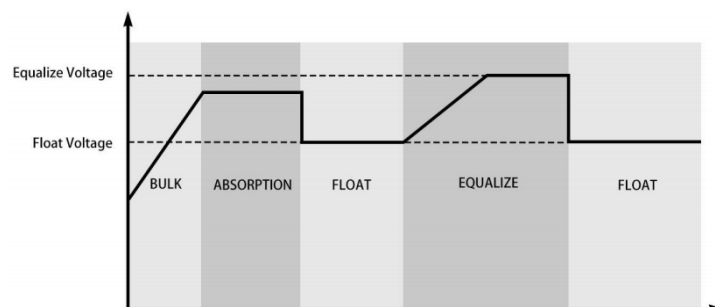

Fig.19

- **Equalize charging time and timeout**

In Equalize stage, the controller will supply power to charge battery as much as possible until battery voltage raises to battery equalization voltage. Then, constant-voltage regulation is applied to maintain battery voltage at the battery equalization voltage. The battery will remain in the Equalize stage until setting battery equalized time is arrived.

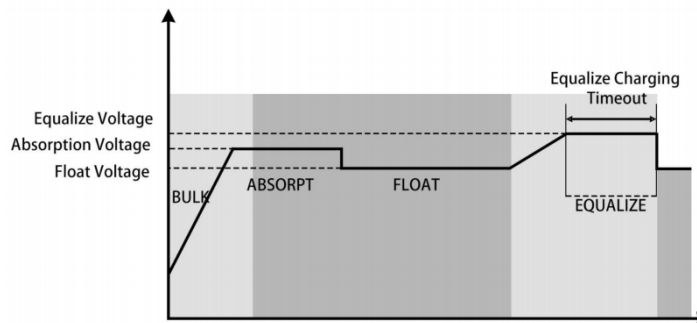

Fig.20

However, in Equalize stage, when battery equalized time is expired and battery voltage doesn't rise to battery equalization voltage point, the charge controller will extend the battery equalized time until battery voltage achieves battery equalization voltage. If battery voltage is still lower than battery equalization voltage when battery equalized timeout setting is over, the charge controller will stop equalization and return to float stage.

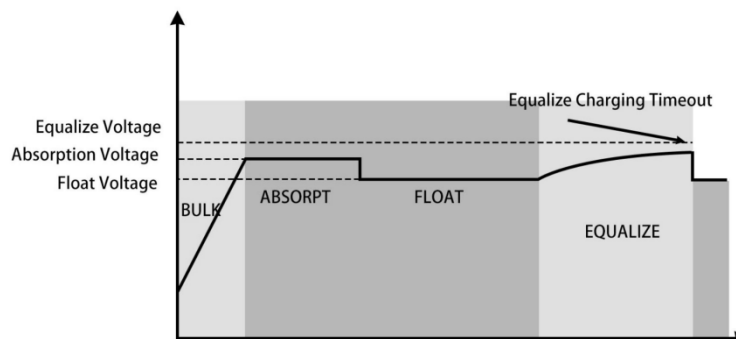

Fig.21



## 08 Specifications

Figure 1 line mode Specifications

<b>INVERTER MODEL</b>	<b>O1-HF-3.6</b>	<b>O1-HF-5.0</b>
Input Voltage Waveform	Sinusoidal (utility or generator)	
Nominal Input Voltage	230Vac	
Low Loss Voltage	170Vac±7V (UPS); 90Vac±7V (Appliances)	
Low Loss Return Voltage	180Vac±7V (UPS); 100Vac±7V (Appliances)	
High Loss Voltage	280Vac±7V	
High Loss Return Voltage	270Vac±7V	
Max AC Input Voltage	300Vac	
Nominal Input Frequency	50Hz / 60Hz (Auto detection)	
Low Loss Frequency	40±1Hz	
Low Loss Return Frequency	42±1Hz	
High Loss Frequency	65±1Hz	
High Loss Return Frequency	63±1Hz	
Output Short Circuit Protection	Circuit Breaker	
Efficiency (Line Mode)	>95% (Rated R load, battery full charged)	
Transfer Time	10ms typical, 20ms Max@ Single <30ms @ Parallel	
Output power derating: When AC input voltage drops to 170V, the output power will be derated.	<p>230Vac model:</p>	

Figure 2 inverter mode Specifications

<b>INVERTER MODEL</b>	<b>O1-HF-3.6</b>	<b>O1-HF-5.0</b>
Rated Output Power	3.5KVA/3.5KW	5KVA/5KW
Output Voltage Waveform	Pure Sine Wave	
Output Voltage Regulation	230Vac±5%	
Output Frequency	50Hz	
Nominal Output Current	15.2 A	21.7 A
Max. Output Fault Current/ Duration	80A/ 300μs	
Max. Output Overcurrent Protection	58A	65A
Peak Efficiency	93%	
Overload Protection	5s@≥150% load; 10s@110%~150% load	
Surge Capacity	2* rated power for 5 seconds	
Nominal DC Input Voltage	48Vdc	
Cold Start Voltage(Lead-Acid Mode)	46.0Vdc	
Cold Start SOC(Li Mode)	Default 30%, Low DC Cut-off SOC +10%	
Low DC Warning Voltage (Lead-Acid Mode)	44.0Vdc @ load < 20% 42.8Vdc @ 20% ≤ load < 50% 40.4Vdc @ load ≥ 50%	
Low DC Warning Return Voltage (Lead-Acid Mode)	46.0Vdc @ load < 20% 44.8Vdc @ 20% ≤ load < 50% 42.4Vdc @ load ≥ 50%	
Low DC Cut-off Voltage (Lead-Acid Mode)	42.0Vdc @ load < 20% 40.8Vdc @ 20% ≤ load < 50% 38.4Vdc @ load ≥ 50%	
Low DC Cut-off Voltage (Li Mode)	42.0Vdc	
Low DC Warning SOC (Li Mode)	Low DC Cut-off SOC +5%	

Low DC Warning Return SOC (Li Mode)	Low DC Cut-off SOC +10%
Low DC Cut-off SOC(Li Mode)	Default 20%, 5%~50% settable
High DC Recovery Voltage	56.4Vdc(C.V. charging voltage)
High DC Cut-off Voltage	60.8Vdc
No Load Power Consumption	<60W

Figure 3 Charge Specifications

<b>Utility Charging Mode</b>		
<b>INVERTER MODEL</b>	<b>O1-HF-3.6</b>	<b>O1-HF-5.0</b>
Charging Algorithm	3-Step	
Max. AC Charging Current	60Amp(@VI/P =230Vac)	80Amp(@VI/P =230Vac)
Bulk Charging Voltage	Flooded Battery	58.4Vdc
	AGM / Gel Battery	56.4Vdc
Floating Charging Voltage	54Vdc	
Charging Curve		
<b>MPPT Solar Charging Mode</b>		
Max. PV Array Power	4500W	6000W
Max. PV Input Current	18 A	
Start-up Voltage	150Vdc±10Vdc	
PV Array MPPT Voltage Range	120Vdc~430Vdc	
Max. PV Array Open Circuit Voltage	450Vdc	

Max. Inverter Back Feed Current To The Array	0A	
Max. PV Charging Current	80A	100A
Max. Charging Current (AC Charger Plus Solar Charger)	80A	100A

Figure 4 General Specifications

<b>INVERTER MODEL</b>	<b>O1-HF-3.6</b>	<b>O1-HF-5.0</b>
Safety Certification	CE	
Operating Temperature Range	0°C to 50°C	
Storage temperature	-15°C~ 60°C	
Humidity	5% to 95% Relative Humidity (Non-condensing)	
Altitude	<2000m	
Dimension(D*W*H), mm	485 x 330 x 135	
Net Weight, kg	11.5	12

## 09 Trouble Shooting

<b>Problem</b>	<b>LCD/LED/Buzzer</b>	<b>Explanation</b>	<b>What to do</b>
Unit shuts down Automatically during startup process.	LCD/LEDs and buzzer will be active for 3 seconds and then complete off.	The battery voltage is too low (<1.91V/Cell)	1. Re-charge battery. 2. Replace battery.
No response after power on.	No indication.	1.The battery voltage is far too low. (<1.4V/Cell) 2.Battery polarity is connected reversed.	1. Check if batteries and the wiring are connected well. 2. Re-charge battery. 3. Replace battery.

Mains exist but the unit works in battery mode.	Input voltage is 0 on the LCD and green LED is flashing.	Input protector is tripped.	Check if AC breaker is tripped and AC wiring is connected well.
	Green LED is flashing.	Insufficient quality of AC power (Shore or Generator)	1.Check if AC wires are too thin and/or too long. 2.Check if generator (if applied) is working well or if input voltage range setting is correct. (UPS→Appliance)
	Green LED is flashing.	Set“Battery First” or“Solar First”as the priority of output source.	Change output source priority to Utility first.
When it’s turned on, internal relay is switching on and off repeatedly.	LCD display and LEDs are flashing	Battery is disconnected.	Check if battery wires are connected well.
Buzzer beeps continuously and red LED is on. (Fault code) Buzzer beeps once every second, and red LED is flashing. (Warning code)	Fault code 02	Fan fault.	1.Check whether all fans are working properly. 2.Replace the fan.
	Fault code 03	Internal temperature of component is over 100°C .	1. Check whether the air flow of the unit is blocked or whether the ambient temperature is too high. 2. Check whether the thermistor plug is loose.
	Fault code 04	Battery is over-charged.  The battery voltage is too high.	Restart the unit, if the error happens again, please return to repair center.  Check if spec and quantity of batteries are meet requirements.

<p>Buzzer beeps continuously and red LED is on. (Fault code)</p> <p>Buzzer beeps once every second, and red LED is flashing. (Warning code)</p>	Fault code 09	Bus voltage is too high.	<p>1. If you connect to a lithium battery without communication, check whether the voltage points of the program 18 and 19 are too high for the lithium battery.</p> <p>2. Restart the unit, if the error happens again, please return to repair center.</p>
	Fault code 10/54/58	Internal components failed.	Restart the unit, if the error happens again, please return to repair center.
	Warning code 16	The input status is different in parallel system.	Check if AC input wires of all inverters are connected well.
	Warning code 17	Input phase is not correct.	Change the input phase S and T wiring.
	Warning code 18	The output phase not correct in parallel.	<p>1. Make sure the parallel setting are the same system (single or parallel; 3P1, 3P2, 3P3).</p> <p>2. Make sure all phases inverters are power on.</p>
	Warning code 21	Li battery can't communicate to the inverter.	<p>1. Check whether communication line is correct connection between inverter and battery.</p> <p>2. Check whether BMS protocol type is correct setting.</p>
	Fault code 52	Over current or surge.	Restart the unit, if the error happens again, please return to repair center.
	Fault code 53	Bus voltage is too low.	
Fault code 56	Output voltage is unbalanced		

	Fault code 57	Battery is not connected well or fuse is burnt.	<ol style="list-style-type: none"> <li>1. If you connect to a lithium battery without communication, check whether the voltage points of the program 18 and 19 are too high for the lithium battery.</li> <li>2. If the battery is connected well, restart the unit. If the error happens again, please return to repair center.</li> </ol>
	Fault code 61	Negative power fault	<ol style="list-style-type: none"> <li>1. Check whether the AC output connected to the grid input.</li> <li>2. Check whether Program 10 settings are the same for all parallel inverters</li> <li>3. Check whether the current sharing cables are connected well in the same parallel phases.</li> <li>4. Check whether all neutral wires of all parallel units are connected together.</li> <li>5. If problem still exists, contact repair center.</li> </ol>
	Fault code 81	CAN fault	<ol style="list-style-type: none"> <li>1. Check whether the parallel communication cables are connected well.</li> <li>2. Check whether Program 20 settings are right for the parallel system.</li> </ol>
	Fault code 82	Host loss	<ol style="list-style-type: none"> <li>3. If problem still exists, contact repair center</li> </ol>

**Note:** To restart the inverter, all power sources need to be disconnected. After the LCD screen light is off, only use the battery to boot.

**SMART ENERGY FOR BETTER LIFE**

**RENAC**

**RENAC POWER TECHNOLOGY CO., LTD.**

Block C-12, No. 20 Datong Road, Comprehensive Bonded Zone, Suzhou Hi-Tech District, Suzhou, China

Tel: +86-0512-66677278

[info@renacpower.com](mailto:info@renacpower.com)

[www.renacpower.com](http://www.renacpower.com)